



SURYA



LIGHTING GUIDE

OVERVIEW

Lighting is one of the most important features to consider when designing a space, for both functionality and ambiance. Whether enhancing your current decor or starting from scratch, it is important to understand which fixtures work best in each space, and where to place them for the best results. This guide includes valuable tips and resources to help you identify the perfect lighting for any space.

Lighting, Fixture and Bulb Types	3
Anatomy of a Lamp	5
Materials and Finishes	11
Sizing and Placement	13
Care and Cleaning	21

LIGHTING, FIXTURE AND BULB TYPES

THE 3 LAYERS OF LIGHTING

Interior light falls into three categories: ambient lighting, task lighting and accent lighting. For the most effective lighting scenario, use a combination of all three for a layered effect.

- **Ambient lighting** provides general lighting that should beautifully radiate from the center of the room.
- **Accent lighting** adds drama to a room by creating visual excitement while casting light on a specific point or object in the room.
- **Task lighting** illuminates an area used for specific tasks such as cooking, working or reading. The key is to ensure a glare-free workspace that is easy on the eyes so that you can focus on the task at hand.

FIXTURE TYPES

Any good lighting plan incorporates an array of different types of lighting fixtures and can make a small room look open and airy, and a large room appear cozy while adding beauty and drama. It should complement your lifestyle and suit your individual needs and those of your family. When planning your lighting, look at the activities that occur in each room, the atmosphere you want to create and the decorative elements you wish to emphasize. Shades help each fixture control light. The shape, material and opacity of the shade will all affect the direction and the diffusion of the light by casting it up or down and reducing any glare.

Below is an overview of the different types of lighting Surya has to offer.

PORTABLE LIGHTING

Portable lighting includes table, floor, ceiling or wall lighting that can be picked up, moved and plugged in wherever there is an electrical outlet. It does not need to be hardwired by a professional.

- **Table/Floor/Task:** Desk, table and floor lamps are largely used as task lights because they're flexible and can be positioned in various locations as needed (like adjacent to a reading chair, or atop a desk for work). They typically provide light in a downward direction, illuminating the surface directly below it rather than providing a general glow, which prevents them from often being used as ambient lights.

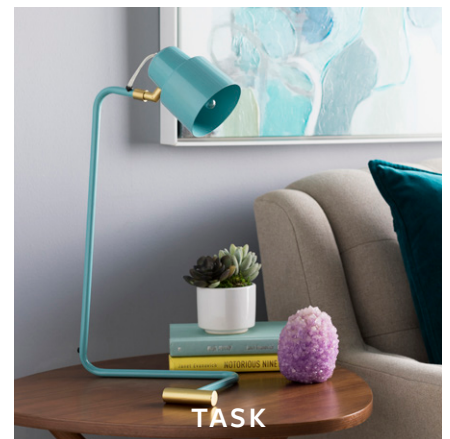

CEILING/WALL-MOUNTED FIXTURES

This broad range of fixtures is, as its name implies, mounted directly to the ceiling or wall by a lighting professional, and typically features a glass, fabric, or plastic shade that conceals the light bulb to help diffuse light more evenly. Mounted fixtures tend to be used to provide ambient light in a room as opposed to accent or task lighting because they provide more general, dispersed lighting.

- **Pendants/chandeliers** are lights that hang from a cable, cord, or pipe from an attachment at a ceiling, ending in a shade enclosing a light bulb that primarily provides light in a downward direction, known as a downlight. Pendants are often located over a table or kitchen island because they provide ambient or task lighting, and usually have strong stylistic elements that bring character to a space because they're so visible.
- **Wall sconces** are some of the most decorative fixtures in the lighting market because they are frequently installed at eye-level in most rooms. They can be either uplights or downlights, providing ambient or task lighting, depending on the fixture, but are rarely powerful enough to provide enough illumination alone to light a large space. They're often found on either side of a fireplace or bed for additional illumination, highlighting these visual focal points in a space.



BULB TYPES

- **Candle:** The candle bulb transports us to another time, one with a very warm and intimate lighting environment. Candle bulbs can add a touch of nostalgic beauty to any room.
- **Compact Fluorescent Bulb (CFL):** These bulbs consume a quarter of the energy that incandescent bulbs do and last 10 times longer. The one hesitation with CFL bulbs is that they contain traces of mercury, so, if broken, it's very important to dispose immediately and keep away from children.
- **Edison:** The Edison bulb is a carbon or tungsten filament light bulb that carries a vintage look reminiscent of the turn of the 20th century.
- **Globe:** The globe bulb is named after its shape. A big burning globe gives a bright and heightened feel to a room.
- **Incandescent:** Incandescent bulbs, the most common household light bulbs, are also the most affordable type of light bulb. This type of light is warm, inviting, and was made for the home. Incandescent bulbs usually last between 700 to 1,000 hours and can be used with a dimmer; however, they're not as energy efficient as some other options.
- **Light Emitting Diode Bulb (LED):** This bulb is long-lasting and extremely energy-efficient. LED bulbs provide only directional light, not diffused light, so they are great for task lighting, and generally not used for ambient lighting.

ANATOMY OF A LAMP

When choosing a lighting plan, it is important to understand that there are many elements to consider. Following are a few illustrations to help identify the basic anatomy of a standard table lamp shade and base.

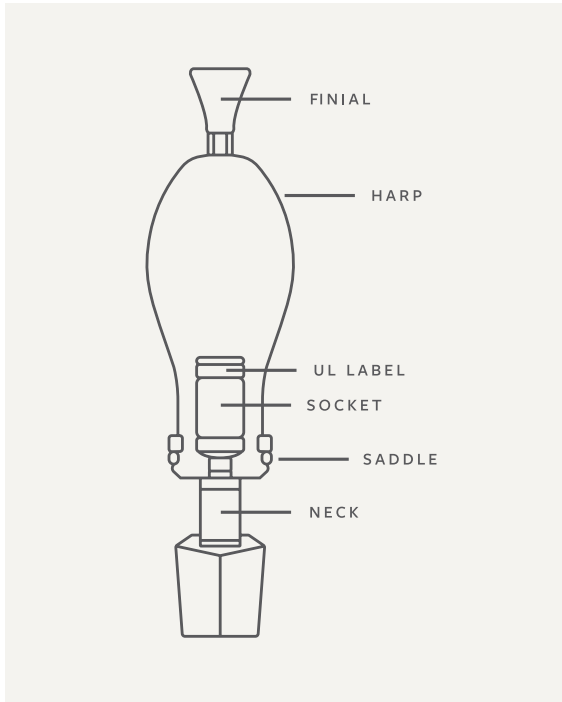

Socket: A threaded screw base used to hold and connect a light bulb to a power source.

Harp: The wire support that attaches at the socket and supports the shade at the top of the lamp.

Saddle: A metal base to which the harp attaches.

Finial: A small finishing ornament that is attached to the top of the harp. This may be simple or ornate.

Neck: The portion of the lamp that connects the harp, saddle and socket to the base of the lamp. The color of the neck should always match the color of the harp.

UL Label: Certifies that an electrical product has been tested and complies with UL standards.

HOW TO MEASURE A LAMP

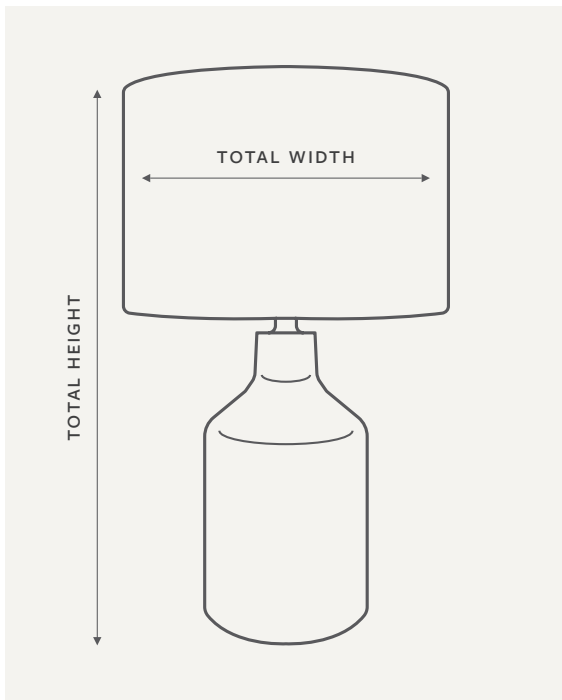

Measuring Total Height

Place the end of the measuring tape at the top edge of the shade, and pull down to the bottom or base of the lamp.

Measuring Total Width

Place the end of the measuring tape at the centermost or widest portion of the shade and pull across the shade of the lamp to the corresponding opposite edge. This will give you the measurement of the total width of the lamp with shade affixed.

SHADE CONSTRUCTIONS

OUTER STRUCTURE

A **hardback lampshade** is typically lined with plastic or another material designed to prevent light from passing through the side of the shade. The hard lining allows the shape of the shade to be quite firm and less likely to change over time. The firm backing is glued into place behind a more attractive outer material.

A **softback lampshade** (stretched) does not have a firm lining although it may still potentially be lined. The lining, however, is flexible, such as linen or paper, and so does not provide support for maintaining the shape of the shade. As a result, the softback or stretched shade requires additional vertical supports between the bottom and the top of the shade to maintain shape.



HARDBACK LAMPSHADE



SOFTBACK LAMPSHADE

INNER STRUCTURE

The inner structure of the shade is as important as the outside construction. The standard constructs of a lampshade include standard framework, full framework and fitter.

Standard framework consists of a top and bottom ring. The top ring is often referred to as the spider and establishes the top diameter and the drop of the shade, while the bottom ring establishes the bottom diameter of the shade.

Full framework contains top and bottom rings that are welded together by ribs. Fabric is usually sewn and stretched over the framework.



A **fitter** is a way the shade connects to the lamp. All fitters are integrated into the lampshade. Most lamps have a spider fitter but are made using the uno or clip-on fitters.

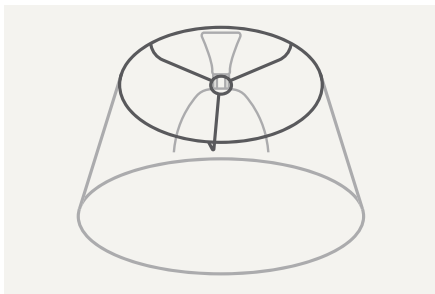

Spider Fitters: If the lamp has a harp, it will have a shade with a spider fitter. The spider fitter sits on top of the harp, is secured by the finial and is integrated in the lampshade.

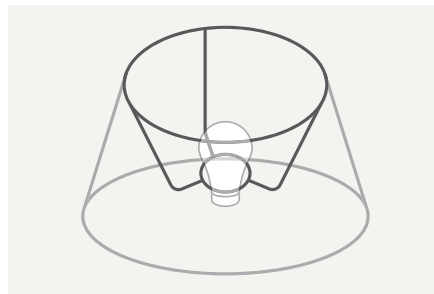

Slip Uno Fitters: The Uno fitter is built into the lampshade. The slip type sits on the socket and is held in place by the bulb.

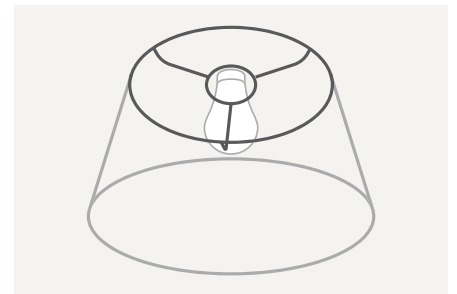

Threaded Uno Fitters: The Uno fitter is built into the lampshade. The threaded type is typically for down-bridge lamps and features a screw thread for installation above the downward-facing bulb.

SHADE SHAPES

Different types of lamp shades correlate to different functions for practical purposes; be it sitting nearby, at a distance, or as an ambient light source. Some lampshades may contain diffusers which are used to obscure the light bulb and diffuse light from the bulb. Diffusers are positioned on the top, bottom or both areas of a shade to guard against debris and dust. They come in acrylic, plastic, metal and glass. Following are some examples of shade types offered by Surya:

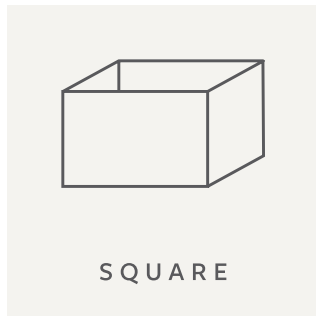
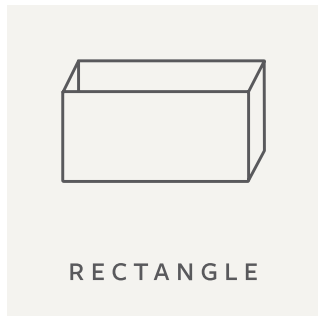
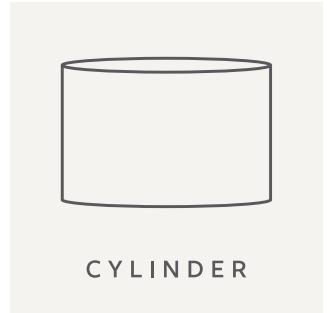
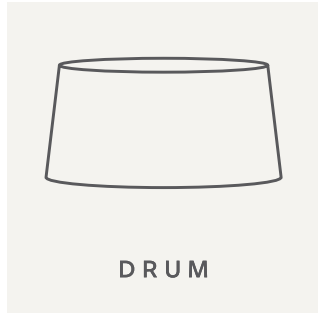

BASE CONSTRUCTIONS

The base of a lamp is the part that connects to the lamp holder and provides electrical contacts. The rod of the lamp is the portion of the lamp that houses the electrical cords inside the base. Base weights are often included in the structure of the lamp in order to provide stability. UL regulations require that floor and table lamps are stable enough to be placed on an eight-degree incline without tipping over. A table lamp's base weight requirement is dependent upon the design of the lamp. Base weights can typically range from 1 to 5lbs. Most frequently, a two-pound weight will be sufficient to comply with the UL standard.

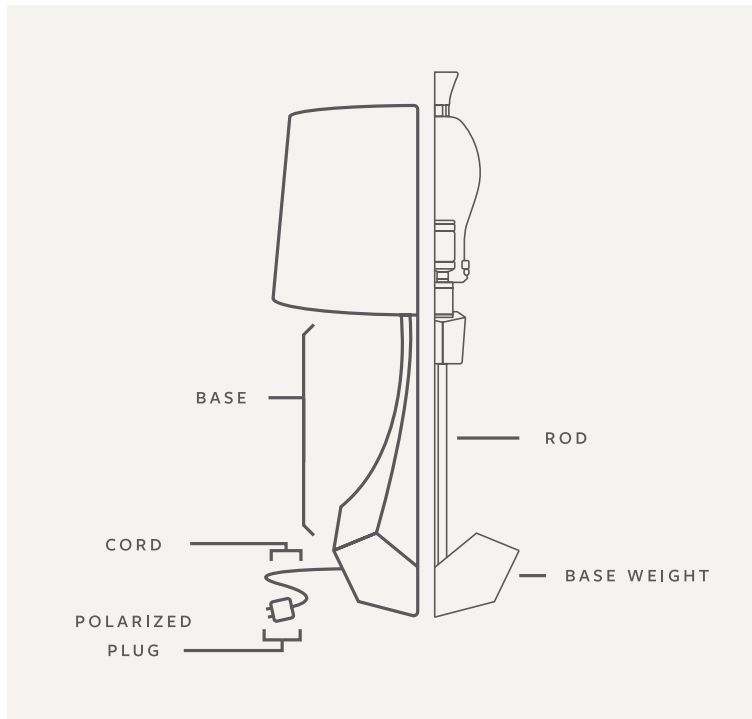

A cord of standard length is attached to the polarized plug. Surya lamp cord length is measured from where the cord exits the lamp to the end of the cord and typically ranges from 8 to 12 feet.

The plug has a small blade for the hot wire and a large blade for the neutral wire to prevent shock from the metal parts of the light.

SWITCH TYPES



3-Way Turn Knob Switch

The 3-way turn knob socket allows a bulb to burn in three positions: Hi, Lo and Off.



On/Off Line Switch

The on/off line switch is a simple on/off rocker switch.



On/Off Line On a Cord Switch

The on/off line on a cord is a convenient way to turn the lamp on and off since the on/off switch is located on the cord line for easy access.



Floor Tap or Foot Step Switch

The on/off switch is maintained on the floor and operated by foot. This is common for floor lamps.



Twin Pull On/Off Chain Switch

The socket switch is operated by pulling on the connected chain.

MATERIALS AND FINISHES

BASE MATERIALS

A lamp base is just as important as the lampshade to have a complete look. Depending on the base material, a lamp or ceiling fixture acts as the finishing touch in a room in the same way that jewelry accessorizes an outfit. It involves a unique combination of lifestyle and functionality. The chart below highlights some of the base materials used in Surya lighting.

	MATERIAL	OTHER CHARACTERISTICS	BENEFITS
	Ceramics	A hard brittle material made by firing clay in a high temperature oven known as a kiln.	Strong durability and scratch resistant. Adds a brightness to any room.
	Crystal	Transparent glass of very high quality, usually with its surface cut into a delicate pattern that reflects light.	Highly durable and decorative properties. Known for clarity and high shine and adds a touch of elegance to any room.
	Glass	Transparent or translucent hard brittle substance.	Fragile material, resistant to corrosion. Provides unique, clean looks.
	MDF/Composition	Medium-density fiberboard is a wood substitute material.	Inexpensive and durable. Can provide a rustic appearance.
	Metal	A solid material that is typically hard, shiny and fusible (e.g., iron, gold, silver, copper, aluminum).	Durable, strikingly beautiful, clean look and versatile.

	MATERIAL	CHARACTERISTICS	BENEFITS
	Wood	A material taken from the trunk or branches of a tree or shrub.	Very durable. Provides a rustic look.

BASE FINISHES

The finishes below represent some of Surya's common options with corresponding characteristics and benefits for each.

FINISH	OTHER CHARACTERISTICS	BENEFITS
Antique	An oil-based protective finish that gives a soft, hand-rubbed luster.	Durable and easily maintained.
Bronze	Smooth finish that is a metallic brown color that resembles the actual alloy bronze.	Versatile and can be used in different styles and room settings. Durable and easy to clean.
Brushed, Nickel	Created by gently rubbing nickel-plated brass with an abrasive pad for a satin finish.	Extremely durable finish.
Pewter	A soft, smooth, matte finish.	Visibly desirable and similar in appearance to silver.
Distressed	Finish is intentionally manipulated to look less than perfect, such as with sandpaper.	Provides a naturally weathered look that is durable.
Glazed	A finish process that involves two hand-detailed techniques. The initial coat of glaze softens the base color. The highlight glaze increases visual depth.	Provides a natural luster and scratch resistant finish.
Natural Finish	Clear finish that adds luster, warmth and character to the wood while protecting it.	Shows natural beauty of the base material.
Painted	Lamp is painted for a rich, beautiful color.	Durable.
White Washed	A staining technique that allows for a brightened or white wood appearance without hiding the wood grain pattern.	Provides a weathered chic appearance. Durable finish that brightens the base because the light is reflected from the white surface.

SIZING AND PLACEMENT

Lighting is an important element for both functionality and ambiance in any room. It can set a romantic mood or offer a bright, playful vibe. The rules of where to hang a light fixture vary from room to room and can sometimes be challenging to master. Below are a few guidelines on size and placement of table lamps, floor lamps, pendants, chandeliers and wall sconces.

LIVING ROOM



A well-lit living room should ideally include some form of layered lighting that illuminates all corners of the room to create balance. Table lamps work alongside decor to bring beauty and light to living spaces. Table lamps are generally placed on a desk, side table, buffet table or another flat surface that gives the lamp the height to softly illuminate a room. Decorating with a pair of table lamps is a popular way to create balance in a space. If a surface is too small for a table lamp, but there is still a need for an additional light source, consider a floor lamp instead. Ceiling lighting such as a dramatic chandelier or a modern pendant can also help to complete the overall look. Lastly, wall sconces are another great source of supplementary light. A popular place to hang wall sconces in the living room is on either side of the fireplace.



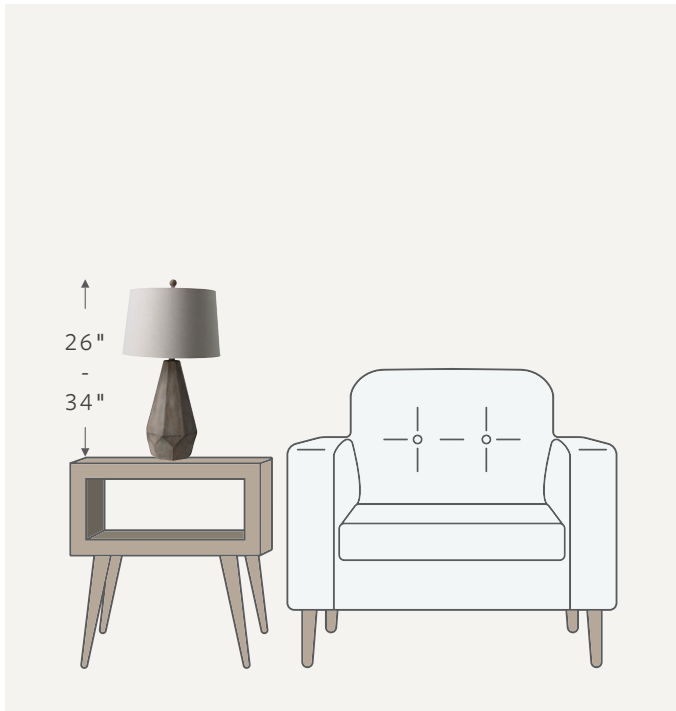

TABLE LAMP

Whether the table is set against a bare wall, beside an armchair or behind a sofa, proper placement of a table lamp ensures that the lighting will illuminate the seating area best, while also providing ambient lighting to the rest of the space. Most living rooms can accommodate table lamps that are 26 - 34 inches tall. To get the best use of the table lamp and its light source, the bottom of the shade should be right at eye level when sitting. If the side table or dedicated surface is too small for a table lamp, but there is a need for adequate reading light, consider a floor lamp.



FLOOR LAMP

The light provided by floor lamps is perfect for reducing shadows created by overhead lighting. Floor lamps near sitting areas should be approximately 68 inches high so that the shade conceals the bulb whether you are standing or sitting next to it. This placement also makes it convenient to run the electrical cord beneath a sofa or chair so it's not an eyesore or tripping hazard.



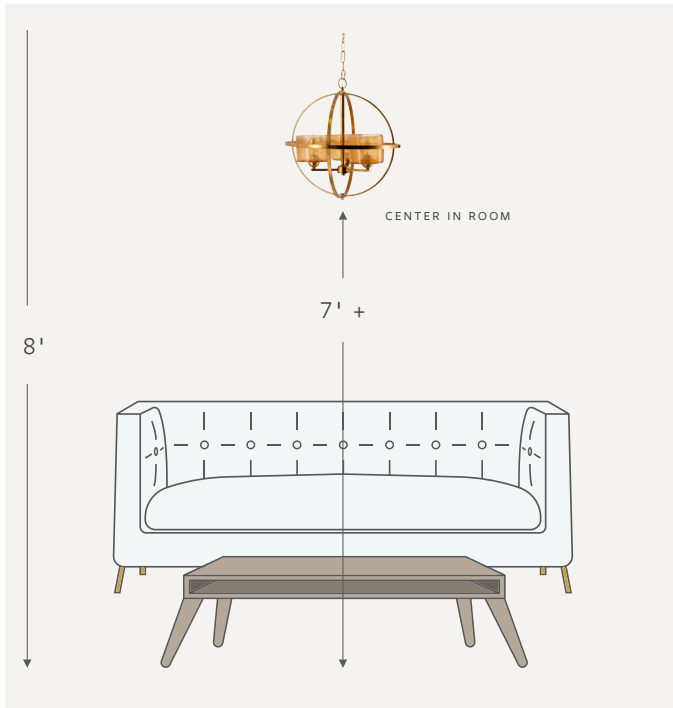

PENDANT

For optimal lighting, the pendant should be positioned in the center of the living space. For an 8 foot ceiling, leave at least 7 feet from floor to the bottom of the light fixture. For a higher ceiling, raise the light by 3 inches for each additional foot. Consider larger and taller chandeliers for ceilings 10 feet and higher. To determine the diameter of a light fixture that best suits the space, measure the length and width of the room in feet, add the two measurements together and swap that value in feet for inches – Ex: 10'L + 12'W = 22 feet so the fixture diameter should be 22 inches. Likewise, to determine the height, multiply the height of the room by 2.5" - 3" per foot – Ex: 10' x 2.5" to 3" = 25 - 30 feet. Swap that value to inches and the ideal fixture height is 25 - 30 inches.

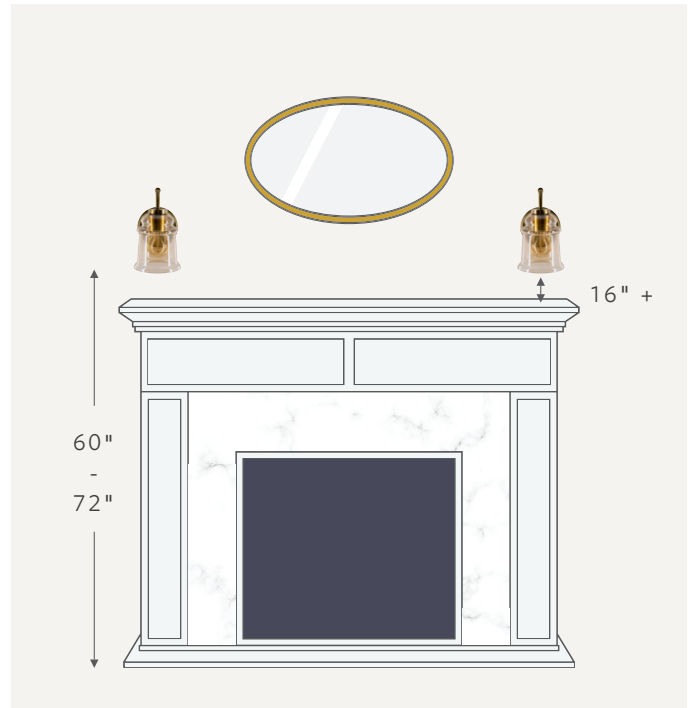

WALL SCONCE

Wall sconces offer a great secondary source of light in large rooms. Most living rooms have an overhead, primary light source like a chandelier, but wall sconces can be used to light up darker areas or far off corners of the room and add a flattering layer of more indirect light. Additionally, wall sconces are used in large spaces to highlight a feature in the room, such as the fireplace. Consider the mantel width from the floor to the bottom of the light fixture. Sconces should be placed approximately 60 - 72 inches from the floor to the center of the backplate. Each sconce should be placed over either end of the mantel at a minimum of 16 inches above the mantel.

DINING ROOM



The dining room is the easiest room to light. The main light source should come from a large pendant or chandelier that is centered over the dining table. A decorative chandelier or pendant in the dining room generally offers a low level of light output and is intended to set the mood and draw the eye to the center of a room. For more functionality, consider using layers of light for a brighter ambiance.



CHANDELIER

Chandeliers should align with the size of the space and dining table. A good rule of thumb is chandeliers should have a diameter of about half to two-thirds the length of the table. For an 8 foot ceiling, leave 30 - 36 inches from the top of the dining table to the bottom of the chandelier. For higher ceilings, raise the chandelier by 3 inches for each foot.



PENDANT

For a modern lighting solution, opt for a pendant above the dining surface. Larger spaces and open-concept rooms will provide more options. Switch it up with a trio of smaller pendants for a unique look, or go with one large statement pendant for a focal point. For an 8 foot ceiling, leave 30 - 36 inches from the top of the dining table to the bottom of the chandelier. For higher ceilings, raise the pendant by 3 inches for each foot. For 3 or more pendants spacing should be at least 30 inches apart, equidistant from the center of the table.

KITCHEN

The key to good kitchen lighting is to rely on an ensemble of lighting sources and to layer lighting, mixing overall ambient light with task or accent lighting. The main source should come from a large, pendant light or several pendant lights grouped together, centered over the kitchen table. This is a great way to provide task lighting while serving as visual and design focal points.

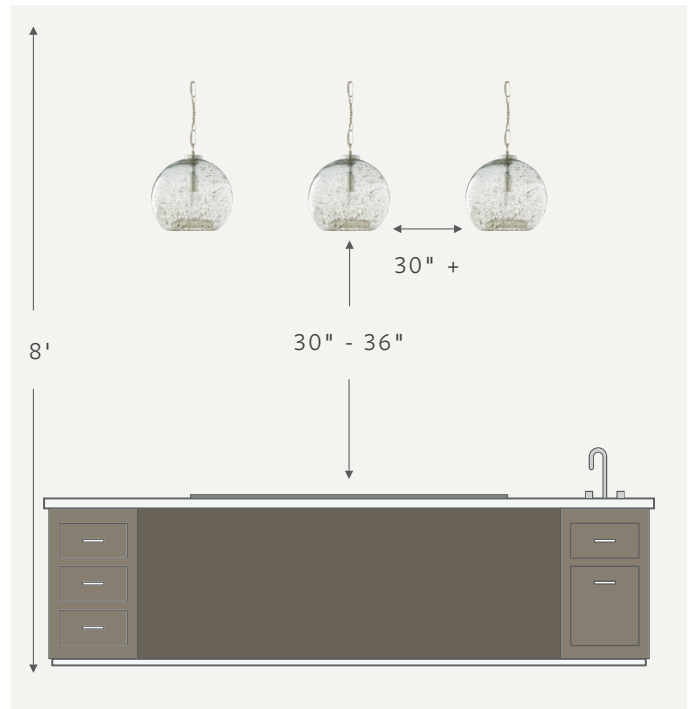
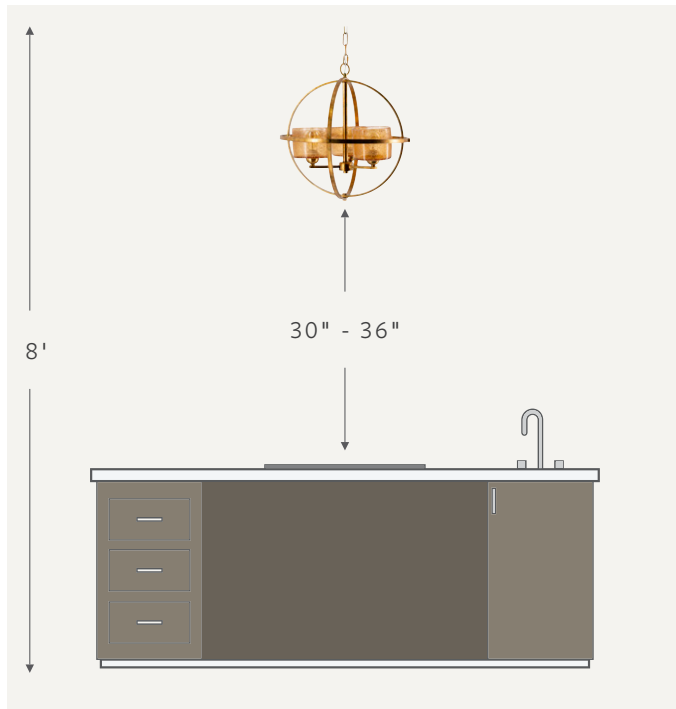

SINGLE OR MULTIPLE PENDANTS

Single pendants and multiple smaller pendants are commonly used to provide ambient and task lighting over a kitchen island or work surface. For an 8 foot ceiling, leave 30 - 36 inches from the top of the island to the bottom of the pendant. For higher ceilings, raise the pendant by 3 inches for each foot. For 3 or more pendants spacing should be at least 30 inches apart, equidistant from the center of the island.

BEDROOM



Several light sources can be used in the bedroom. Try ceiling lights for overall ambient lighting or reading, and table or floor lamps for added task lighting. Wall sconces or smaller pendants also provide a great alternative to bedside lamps. They free up surface space and provide a balanced focus.

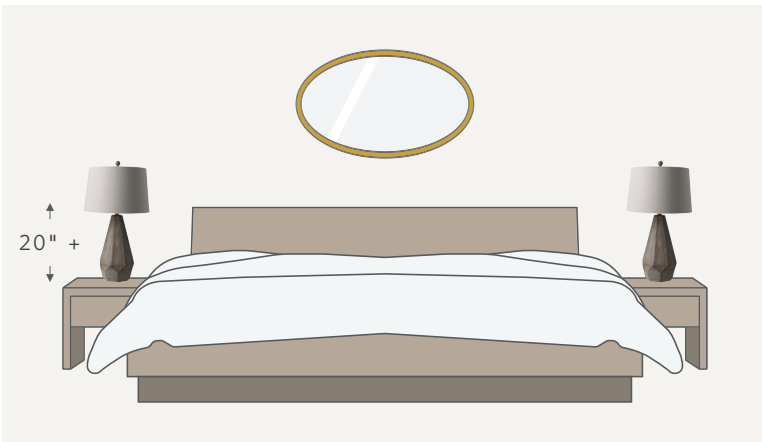
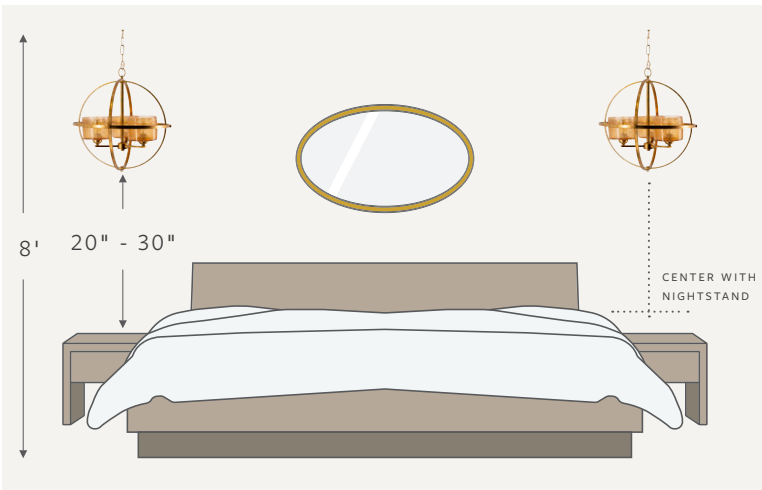

TABLE LAMP

It is best to place a table lamp closer to you or towards the back of the nightstand. This will help give you enough space to place other objects on the nightstand and the light will still illuminate the task and the room as needed. When laying down, the bottom of the table lamp shade should be at least 20 inches high from the surface to get the best use out of the light while using in bed. Assuming that the nightstand is the same height as the mattress, the ideal bedside lamp should be the same height as the nightstand plus an extra two or three inches. So, if the nightstand is 24 inches high, a lamp that is around 27 inches tall will look best.



PENDANT

Pendant lighting can be hung on either side of the bed and used as an alternative to a bedside table lamp or wall sconce. It can even be positioned over the foot of the bed (as long as the light fixture is hung high enough that you can avoid hitting it when you get in and out of the bed). Place pendants on either side of the bed 20 - 30 inches from nightstand surface to fixture base, comfortably centered above nightstand and close enough that the switch can be easily accessed.

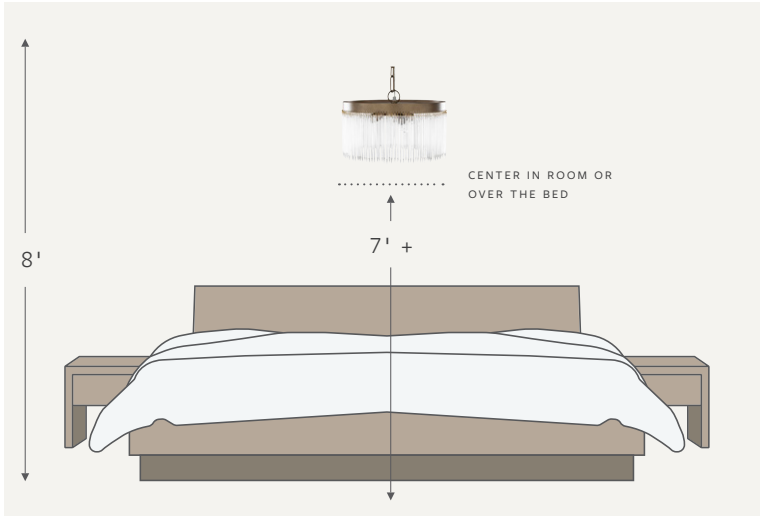

CHANDELIER

Generally, the lower you hang the fixture, the larger it should be. For a small bedroom, keep the chandelier to no more than 20 inches in diameter. In a larger bedroom, limit the chandelier to no more than 30 inches across. It is best not to hang a chandelier directly over the head of a bed but more towards the center of the room or the lower third of the bed. For an 8 foot ceiling, leave at least 7 feet from floor to the bottom of the light fixture. If you have a higher ceiling, raise the light by 3 inches for each additional foot. Consider larger and taller chandeliers for ceilings 10 feet and higher.



ENTRYWAY/HALLWAY

Whether you pick a light fixture that makes a bold statement or something more subtle and subdued, the choice of entryway lighting sets the tone for the rest of the house. The higher the ceiling, the taller the chandelier or pendant. A standard 8 foot ceiling requires a chandelier or pendant that is 20 - 24 inches in height. A quick way to figure out the recommended fixture diameter is to add the length and the width of the room considering the sum as inches and you will have the suggested diameter of the chandelier or pendant for that space.

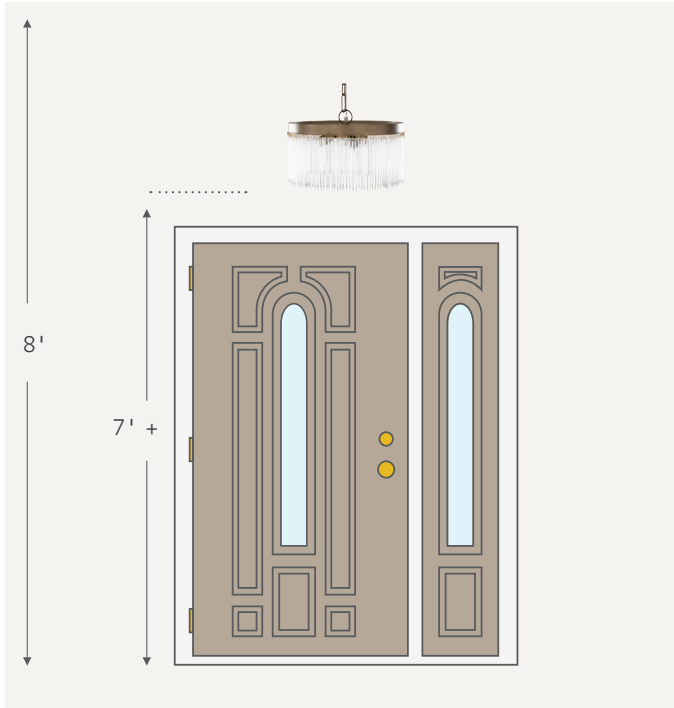

CHANDELIER/PENDANT

For an 8 foot ceiling, leave at least 7 feet from floor to the bottom of the chandelier. If you have a higher ceiling, raise the pendant by 3 inches for each additional foot. Choose a fixture that is proportional to the space of the entryway. For example, if the entryway has 75 square feet of space or more, look for a pendant or chandelier with a diameter of at least 12 - 18 inches. Smaller entryways look better with smaller chandeliers unless you want the fixture to serve as a focal point.

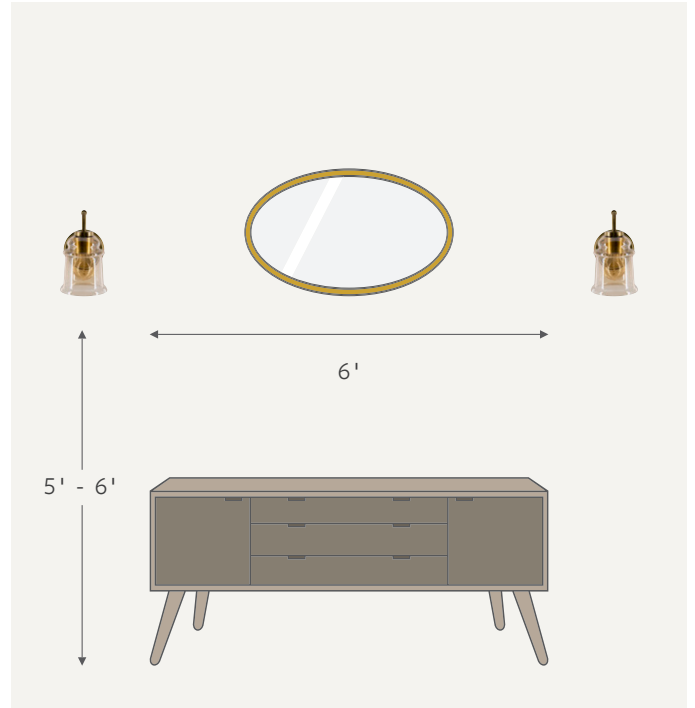

WALL SCONCE

Wall sconces add a welcoming glow to the entryway without taking up valuable real estate on a console table or the entryway furniture. Use one on either side of the door or an entryway system. Depending on ceiling height most wall sconces should be placed 5 - 6 feet from the floor. If placing multiples in a long hallway or on either side of wall décor, keep at least 6 feet between each wall sconce to help ensure that light fills the entire stretch with no awkward gaps.

CARE & CLEANING

As a general rule, do not use harsh abrasives, polishes or chemicals on any lighting fixtures or shades. They can damage the finish.

FABRIC SHADES

- Dust regularly with a feather duster or a soft dry cloth.
- To remove dirt and grime, use a lint brush or fine bristle brush and rub gently.
- Remove stains and accumulated dust using a soft white cloth or sponge and a solution of mild detergent and warm water. Gently wash away the dirt or stain and then rinse with a clean cloth and fresh water. Allow the shade to dry in the sun or with the use of a hairdryer.
- Take care not to wrinkle or crush the fabric when cleaning or drying your shade.

CERAMIC BASES

- Dust regularly using a soft cloth or furniture duster.
- When necessary, clean the base of your ceramic lamp using a soft clean cloth and a solution of mild soap and warm water. Wipe thoroughly, but gently, then rinse using a clean cloth and fresh cold water.

CRYSTAL BASES & ACCENT PIECES

- Dust gently on a routine basis using a feather duster.
- Wipe the crystal surface and all accent pieces with a clean, soft cloth regularly to maintain the brilliancy of the crystals.

METAL BASES

- Dust regularly with a feather duster or a soft dry cloth.
- When more thorough cleaning is necessary, use mild soap and warm water and lightly wipe the surface using a soft white cloth. Rinse using fresh water and a soft white cloth to remove all soap residue. Dry thoroughly with a soft cloth.

COMPOSITE & PAINTED BASES

- Dust regularly with a feather duster or a soft dry cloth.
- Remove accumulated dirt by wiping the entire base with a soft clean cloth and a solution of warm water and mild soap. Rinse with fresh water and a clean cloth and then dry thoroughly using a soft clean cloth.

BRASS BASES

- Brass lighting fixtures are protected with a coat of clear lacquer to keep the finish from tarnishing, so brass polish is not necessary. Damage to this protective coating from harsh cleaning products may lead to a tarnished finish.
- Dust regularly with a feather duster or a soft dry cloth.
- To remove accumulated dirt use mild soap and warm water and lightly wipe the surface using a soft white cloth. Rinse using fresh water and a soft white cloth to remove all soap residue. Dry thoroughly with a soft cloth.

WOOD BASES

- Dust regularly using a soft cloth or furniture duster.
- Occasional treatments using lemon oil will prevent the wood from drying while also helping to preserve the luster of the finish. Apply a small amount of lemon oil to a soft clean cloth (do not put the oil directly on the wood base). Gently rub the oil over the entire surface of the wood base. Buff to finish with a soft clean cloth.

OUTDOOR LIGHTING

- Routinely wipe the exterior surface of outdoor lighting fixtures with a soft clean cloth.
- Use glass cleaner to keep the glass clean and clear.
- Car wax can be used twice annually on any metal surfacing to preserve and protect the finish of your outdoor lighting fixture.





INFO@SURYA.COM | 877.275.7847 | @SURYASOCIAL | SURYA.COM